

Critical energies for ssb and dsb induction in plasmid DNA by vacuum-UV photons: an arrangement for irradiating dry or hydrated DNA with monochromatic photons

M. FOLKARD*, K. M. PRISE, B. VOJNOVIC, B. BROCKLEHURST† and B. D. MICHAEL

(Received 11 June 1999; accepted 11 October 1999)

Abstract.

Purpose: Theoretical modelling techniques are often used to simulate the action of ionizing radiations on cells at the nanometre level. Using monoenergetic vacuum-UV (VUV) radiation to irradiate DNA either dry or humidified, the action spectra for the induction of DNA damage by low energy photons and the role of water and can be studied. These data provide inputs for the theoretical models.

Methods: Various combinations of monochromator, grating and VUV window have been used to obtain monochromatic photons from the 2 GeV electron synchrotron at the CLRC, Daresbury Laboratory. A sample chamber containing plasmid DNA is installed at the end of the beamline. The chamber can be evacuated or water can be introduced (as water vapour or humidified helium). In this way, DNA can be irradiated either dry or humidified.

Results: An arrangement for irradiating dry or humidified DNA using monoenergetic photons from 7 eV to 150 eV has been developed. At the energies used, exposure rates vary from about 5×10^{10} to 3×10^{12} photons $\text{cm}^{-2} \text{s}^{-1}$ over a 1 cm^2 sample area. At all but the lowest energies this is sufficient to produce significant levels of DNA damage in just a few minutes. The measured dose variation over the sample area is typically 30%, but this is reduced significantly using sample scanning techniques.

1. Introduction

One of the fundamental aims of radiation biology is to develop a complete mechanistic description of the processes and subsequent biological effects that follow the initial energy deposition by ionizing radiation. There is now a substantial body of theoretical work that addresses the relationship between radiation quality and the amount of energy deposited in the DNA helix. Monte Carlo track structure techniques are being used with increasing sophistication to simulate the distinctive spatial properties of a wide range of ionizing radiations, and continue to have a significant impact on the understanding of how radiations deposit energy in tissue at the molecular level

(Goodhead 1994, Ottolenghi *et al.* 1997, Nikjoo *et al.* 1997, 1998, Friedland *et al.* 1998). What follows as a consequence of the initial energy deposition, however, is less clear. For example, the relationship between the amount of energy deposited within a small section of DNA (and nearby water molecules) and the type and severity of damage induced is still the subject of much speculation.

It is known from experimental (Rauth and Simpson 1964, Johnson and Rymer 1967) and theoretical (Pimblott and LaVerne 1995) studies that the most frequent localized energy depositions in DNA are in the order of a few tens of electron volts. Furthermore, the modelling studies show that low-LET radiations produce very few energy depositions $> 200 \text{ eV}$ (Nikjoo *et al.* 1991). Historically, experimental investigations in this energy range have been sporadic, due in part to the practical difficulties that arise when low-energy ionizing radiations are used. Also, for studies in the vacuum ultra-violet (VUV) region, only the effect on dry DNA has been investigated. Early work by Lücke-Huhle and Jung (1973a,b) used discrete energies (4.9 eV to 19.8 eV) from metastably excited gases to irradiate ϕX174 DNA; however, they concluded that the actions were unlike those of ionizing radiations. Wirths and Jung (1972) and Sontag and Dertinger (1975) both used VUV to investigate the induction of ssb and inactivation in dry ϕX174 DNA. More recent studies (Bothe *et al.* 1990, Gurzadyan and Görner 1993) have used $\sim 5\text{--}6 \text{ eV}$ pulsed laser light to investigate ssb and dsb induction in solutions of calf thymus or plasmid DNA. Other recent studies have used synchrotron VUV sources to measure damage in micro-organisms and the induction of ssb and dsb. Ito (1992) has studied the effects of 50–190 nm radiation on *Bacillus subtilis* spores and pBR322 plasmid DNA, and Hieda *et al.* (1994) have measured the yield of ssb and dsb in dry pBR322 plasmid DNA for selected photon energies in the range 8.3 eV to 20.7 eV. Similar studies have been reported previously by ourselves

*Author for correspondence. e-mail: folkard@graylab.ac.uk

Gray Laboratory Cancer Research Trust, PO Box 100, Mount Vernon Hospital, Northwood, Middlesex HA6 2JR, UK.

†Department of Chemistry, University of Sheffield, Sheffield S3 7HF, UK.

using dry pBR322 and pMSG-CAT plasmid DNA exposed to monoenergetic photons in the energy range 7–25 eV (Michael *et al.* 1994, 1995). Finally, an earlier study by the present authors used a low energy electron source to irradiate dry pBR322 DNA with monoenergetic electrons in the energy range 25–4000 eV (Folkard *et al.* 1993). One of the significant findings of this work was that electrons with an energy of 50 eV could produce both DNA ssb and dsb, while 25 eV electrons produced ssb, but did not appear to produce dsb. The authors acknowledged, however, that the data were compromised, to some extent, by the very shallow penetration of low energy electrons (and hence, the desirability of using VUV photons).

This paper describes the development of experimental techniques using synchrotron radiation for quantifying the action of radiation on DNA in terms of the amount of energy deposited at the site of damage and the hydration state of the DNA. Subsequent papers will report the findings of experiments performed using this facility. So far, relatively few systems for this type of study have been developed using synchrotron radiation (i.e. Ito *et al.* 1984). The experiments are performed using initially supercoiled plasmid DNA. After exposure, gel electrophoresis is used to measure the loss of supercoiled DNA (predominately due to ssb induction) and the induction of linear DNA (due to dsb induction). Monochromatic VUV synchrotron radiation was used to irradiate plasmid DNA in the energy range 7–150 eV. The aim has been to establish the action-spectra for the induction of DNA single-strand breaks (ssb) and double-strand breaks (dsb) in dry and hydrated DNA, and to determine the minimum energy required to produce ssb and dsb. The apparatus for irradiating the DNA can be configured in a number of ways, depending on the requirements of the experiment. Arrangements exist for irradiating DNA in the dry state (i.e. in vacuum) and with the DNA hydrated, either by humidified helium or by a partial pressure vapour.

2. Methods

2.1. VUV radiation source

The source of radiation for this study is the 2 GeV electron synchrotron at the Council for the Central Laboratory of the Research Councils (CCLRC), Daresbury Laboratory, Warrington, UK. Irradiations were carried out either on Station 3.1 or Station 3.3, depending on the photon energies required. Station 3.1 comprises a Seya-Namioka 1 m monochromator (Seya) with a choice of a 'low' and 'high' grating

(optimized for different regions of the energy spectrum) that can be interchanged while at high vacuum. Station 3.3 uses a toroidal grating monochromator (TGM), also fitted with interchangeable 'low' and 'high' gratings (different from those used on Station 3.1). The Seya was used for studies in the energy range 7 eV to 25 eV, while the TGM was used for energies higher than this (40 eV to 150 eV). The arrangement for irradiating DNA samples has undergone a number of developments and improvements since its inception. Initially, studies were carried out using a system where the DNA could be irradiated under vacuum only (Michael *et al.* 1994, 1995). This arrangement has been superseded by a substantially modified system that can be used for irradiating DNA either in vacuum or in a hydrated condition. Both arrangements are described below.

2.2. Irradiating the DNA in vacuum

The original arrangement for irradiating DNA samples in vacuum is illustrated in figure 1. When coupled to the synchrotron, the left-most window valve in the figure is 30–60 cm from the horizontal exit slit of either monochromator. The slit-width and the distance from the slit determine the size and the distribution of VUV photons at the sample position. Normally, the slits are opened fully to maximize the spread of photons.

The prepared DNA sample (see §2.4) is supported on a modified NW40 vacuum flange within the vacuum at the end of the beamline. The photon flux at the sample position is monitored by measuring the photo-current from a -18 V biased, electrically insulated fine copper mesh (88% transmitting), through which the beam passes (see figure 1). During an exposure, the photo-current from the copper grid is integrated on a Keithley 616 electrometer. The photo-current from the grid is calibrated prior to each experiment using a silicon photodiode (type AXUV-100; IRD, Torrance, CA, USA) located within the vacuum, at the sample position. The diode has an area of 100 mm², but is masked by a 5 mm diameter aperture to define the area of the photodiode actually irradiated. The quantum efficiency of this device has been determined by the National Institute of Standards and Technology (NIST) (Gaithesburg, UK) in the energy range 5–250 eV. The photo-current from the diode is measured using a second Keithley 616 electrometer under virtual earth input conditions.

By means of a flexible bellows coupling, the final 5 cm of the beamline (supporting the sample) can be precisely moved up to 2 cm off-axis, in any direction orthogonal to the beam direction. This section of

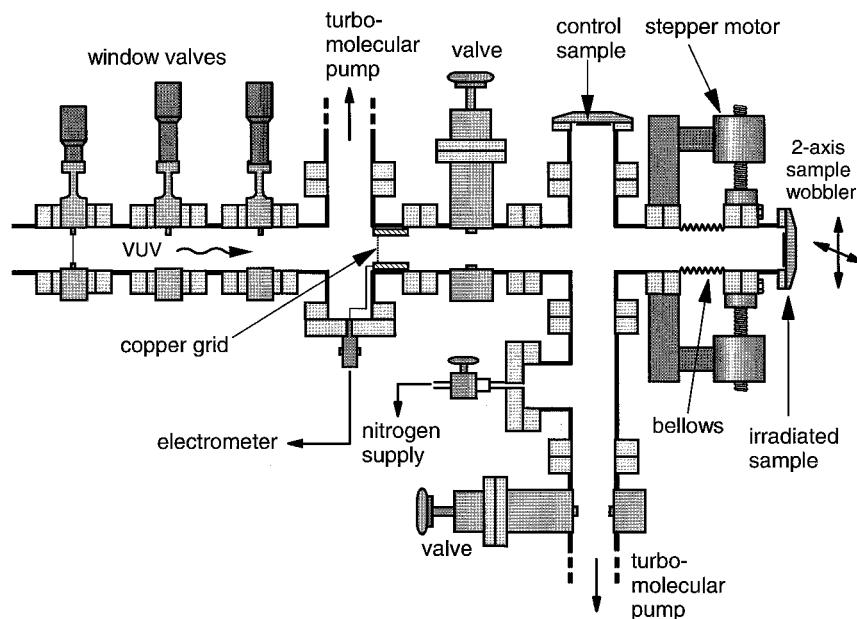

Figure 1. The original system for irradiating DNA in vacuum.

beamline is supported and positioned by an arrangement of four computer-controlled stepper motors. The ability to position the sample in this way serves several functions. First, it allows the sample to be positioned accurately and routinely with respect to the beam. The beam position is checked periodically during the day by installing a quartz window instead of the sample holder. The window has registration marks indicating the sample region, and is coated on the vacuum side with a film of sodium salicylate, such that it is possible to ascertain the distribution of incident VUV radiation by observing the fluorescence. This is just visible to the (dark-adapted) naked eye, but can be readily seen using an image-intensified telescope. Secondly, it is possible to study the dose distribution at the sample position by scanning the photodiode (covered by a mask with a 1 mm diameter aperture) through the beam. Finally, the sample can be rocked either horizontally or vertically, or raster-scanned within the beam during irradiation to reduce the dose variation across the sample, and to remove shadowing artefacts caused by the copper grid. Note that each irradiated sample is paired with a control sample that is subject to the same vacuum cycle, but is not exposed to VUV light. After irradiation, the sample chamber is refilled to atmospheric pressure with dry nitrogen before removal of the control and irradiated samples.

For all experiments, radiation reaching the sample position first passes through one of three filters, each mounted in a separate window valve (model no. PN 01032-UE01-X; VAT Vacuum Products Ltd, London, UK). The purpose of these filters is twofold: first, to

separate the ultra-high vacuum conditions that exist within the monochromator ($\sim 10^{-10}$ to 10^{-11} mbar) from the poor vacuum of the sample chamber ($\sim 10^{-3}$ to 10^{-5} mbar); and secondly, at certain energies they can be used to block second-order contaminating radiation that is a characteristic of both monochromators. The filter is selected according to the photon energy being used (see §3). Experiments were performed at ten different energies from 7 eV to 150 eV. Below 11.5 eV, a 1.75 mm thick by 16 mm diameter VUV grade lithium fluoride window (AG Electro-Optics, Tarporley, UK) is installed. For other energies, either an aluminium (which transmits photons above ~ 18 eV) or a polyimide filter is used. The aluminium and polyimide filters are 100–150 nm thick by 25 mm diameter, and are supplied mounted on a supporting nickel mesh (Luxel Corporation, Friday Harbor, WA, USA).

2.3. Irradiating the DNA in a hydrated state

To irradiate the DNA in a condition where water is also present is less straightforward. In principle, it is possible to expose the DNA in solution to VUV photons, provided that account is taken of the severe attenuation of the radiation through the liquid (inevitably, the chamber containing the DNA solution would have to be very thin). In practice, it is difficult at some energies to find a suitable VUV window to separate the vacuum from the solution. Several alternative methods for hydrating the DNA have been developed and used by the present authors.

For energies below 11.5 eV (i.e. the cut-off for

transmission through lithium fluoride) the arrangement shown in figure 2 is used. This replaces the sample scanning system at the end of the beamline shown in figure 1. The DNA is prepared on an 18 mm square, zero-gauge glass cover slip (see §2.4), which is supported on a threaded arm assembly within a sealed chamber facing the VUV window. By rotating the arm assembly, the window-to-sample distance can be set precisely (for this study, a distance of 0.5 mm was used). A second DNA sample can be mounted behind this sample. The second sample serves as a control, and is subjected to the same environmental conditions as the irradiated sample (but is shielded from the radiation). Note that figure 2 shows the chamber disassembled (i.e. for sample changing), while figure 3 (discussed below) depicts the chamber assembled.

The cavity containing the samples can be evacuated or flushed with gas using an arrangement of bellows and valves that couple either a turbomolecular pump or gassing system to the chamber. With the pump connected, a pressure $< 10^{-5}$ mbar (measured close to the pump) is achieved in a few minutes. Alternatively, with the gassing system connected, the sample chamber can be flushed continuously with high-purity helium, which is completely transmitting to VUV photons in the LiF window region. A gas-exchange bottle between the helium supply and the sample chamber fully humidifies the gas before it enters the chamber. The bottle contains de-ionized water and stands in a temperature-controlled waterbath (set slightly below room temperature to prevent condensation occurring in the

sample chamber). The flow of humidified helium is used to rehydrate the DNA prior to and during the irradiation. The outflow of gas from the chamber is fed to an oxygen level meter to verify the absence of air (Thermox II analyser), which would otherwise have an undesirable attenuating effect. Measurements using the silicon photodiode are made in the chamber at the sample position, which is either evacuated, or flushed with gas. In the energy range 7–11 eV, the measured photon fluxes under vacuum and dry helium are the same. Introducing humidified helium lowers the intensity at the sample position by 12%. This reduction in intensity varies by about $\pm 3\%$, from exposure to exposure.

For experiments above 11.5 eV, the choice of suitable window material is limited, and only very thin (and therefore fragile) windows can be used. In this instance, a 25 mm diameter by 150 nm thick polyimide window was used, which was similar to that used in the window valve. The window is not sufficiently robust to support atmospheric pressure, and therefore simply flushing humidified helium through the chamber is not possible (also, helium will absorb VUV photons above 24 eV). Instead, humidification is achieved by first evacuating the chamber, then introducing water vapour at a partial pressure that depends on the water temperature. The arrangement for doing this is shown in figure 3. The humidification process must not expose the polyimide window to large pressure differentials (the window can withstand up to 50 mbar pressure difference). With the sample in position, valves 1, 4 and the gate valve are closed, while valves 2 and 3 are opened,

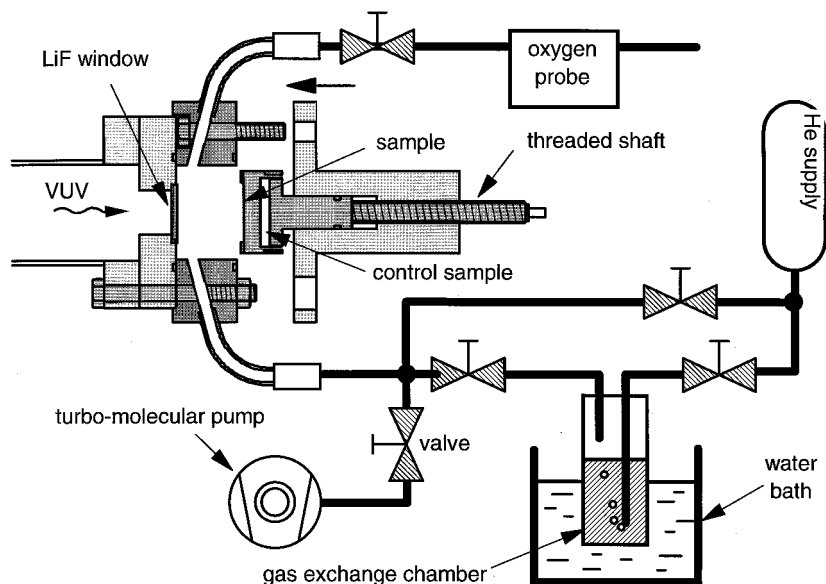

Figure 2. The sample chamber (shown disassembled) and humidification system used to irradiate DNA with photons from 7 eV to 11 eV.

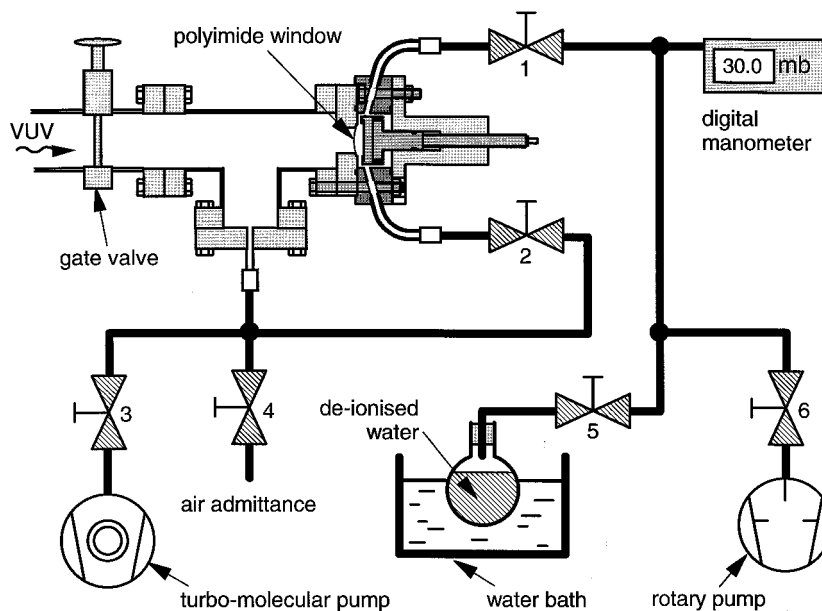

Figure 3. The sample chamber and humidification system used to irradiate DNA with photons from 70 eV to 150 eV. The numbered valves are referred to in the text.

such that both sides of the window are similarly evacuated by the turbo-molecular pump. Meanwhile (with valves 5 and 6 open) a rotary pump is used to evacuate a sealed vessel containing de-ionized water, and placed in a temperature-controlled waterbath. The vessel is connected to the sample chamber through valve 1 (currently closed). Once both sections are evacuated, the rotary pump is isolated from the water vessel by closing valve 6, and the sample chamber is isolated from the rest of the beamline by closing valve 2. Valve 1 is then opened such that the DNA samples are exposed to the water vapour at a partial pressure that depends on the water temperature. At a typical temperature of 25°C, the partial pressure of water is 30 mbar. A digital strain-gauge manometer (Edwards, Crawley, UK) is used to monitor the water vapour pressure. The evaporation caused by pumping the water also cools it; therefore the system is allowed to equilibrate to the desired temperature before the sample is irradiated. When using the polyimide window, the window-to-sample distance is 4 mm (the closest achievable distance). The photon fluence is measured using the silicon diode in vacuum, and the absorption due to the water vapour is calculated using the data of Henke *et al.* (1993).

Note that the hydration system is too bulky to be used in conjunction with the sample positioning system described for use with dry DNA experiments. In this instance, reducing the effect of copper-grid shadowing and improving the dose uniformity is achieved by rotating the sample 180° on its threaded

shaft halfway through the exposure. This will change the window-to-sample distance by 0.5 mm (because the rotating action uses a 1 mm pitch threaded shaft), and this is accounted for in the dosimetry by measuring the dose at the two positions.

2.4. DNA sample preparation

For these studies, two plasmids have been used: pBR322 (4363 bp) and the larger pMSG-CAT (8404 bp), which has a greater responsiveness due to the increased target size. Details of the DNA sample preparation are given in a subsequent paper, as are the methods used to evaluate the fraction of induced *ssb* and *dsb* by measuring the loss of initially supercoiled DNA and the formation of linear DNA. A critical requirement of the preparation is to present the DNA to the radiation as a monolayer, otherwise artefacts due to shielding from overlying DNA molecules will mask the dose-response. To do this, a freeze-drying technique has been developed that allows the DNA to be spread in solution over the exposure area, and then the water can be removed under vacuum while frozen. Freezing the sample in this way eliminates the tendency for the DNA to aggregate within droplets as it dries. A diagram of the current freeze-drying system is shown in figure 4, and has been designed to be as compact as practicable, such that frequent transportation to and from Daresbury Laboratory is straightforward. Up to 25 DNA samples can be loaded onto a 100 mm square copper platter, which is coupled to a 220 mm diameter

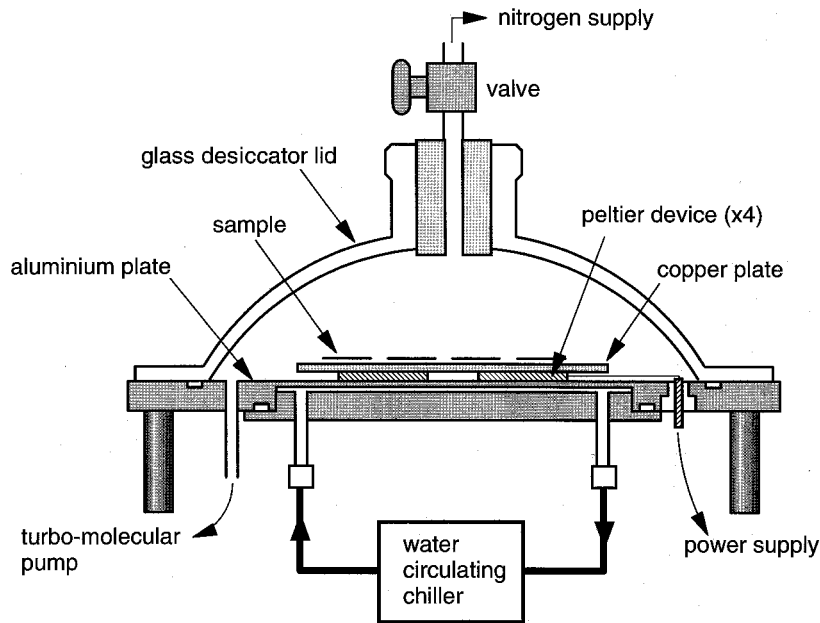

Figure 4. The arrangement for freeze-drying DNA samples.

aluminium base by four 33 W Peltier devices. The base is cooled by pumping chilled water (at 4°C) through a cavity within the base and will conduct heat away from the Peltier devices, which (when energised) reduce the temperature of the copper platter to about -12°C. The base also forms a vacuum seal with a glass desiccator lid to facilitate evacuation of the samples (and therefore removal of the water) once frozen.

A 1 µl sample of DNA is spread over a defined region (up to 10 mm square, depending on the beam distribution) in the centre of a prepared 18 mm square glass coverslip. Once spread, the coverslips are immediately placed on the cooled copper platter (at about -12°C). Dry nitrogen is flushed through the chamber while the samples are being loaded to prevent the build-up of ice on the platter due to moisture in the air. In batches of 25, the coverslips are then freeze-dried for about 40 min at 10⁻⁵ mbar. At the end of the freeze-drying process, the chamber is slowly returned to ambient temperature, and then to atmospheric pressure using dry nitrogen. The samples are then removed and stored in dry nitrogen until they are required. This procedure introduces little, or no, background damage to the DNA (which is initially > 90% supercoiled).

This method of sample preparation has been used for both dry and hydrated DNA experiments; however, a number of other preparation methods have been used for hydrated studies, specifically to investigate the rehydration process of the DNA. These, and other matters relating to the hydration status of the

DNA before and during irradiations, will be discussed in a future publication.

2.5. Photon absorption by DNA

Using the photodiode, the photo-current from the copper mesh (used to monitor the dose) is readily calibrated in units of incident photons on the sample per cm². In some instances, it is desirable to express the yield of strand breaks in terms of the number of photons absorbed in the DNA (i.e. the quantum yield of strand breaks). The number of absorbed photons can be estimated using data for the optical properties of DNA at the energies of interest. Little useful data exists in the VUV region. Data of relevance are, firstly, the measurements of Inagaki *et al.* (1974), who have measured the transmission of thin films of calf thymus DNA to determine its optical and dielectric properties over the energy range of 4–82 eV, and secondly, the tabulated elemental photon absorption cross-sections at selected energies from 10.2 eV to 30 keV by Henke *et al.* (1993).

Using the data of Inagaki *et al.* (1974), the absorption cross section, σ , can be calculated from the extinction coefficient, κ , and the photon wavelength, λ , thus:

$$\sigma = (4\pi\kappa/\lambda) m_p / \rho$$

where m_p is the mass of one plasmid molecule and ρ is the density of DNA.

Between 40 eV and 150 eV, the tabulations of Henke *et al.* (1993) have been used to calculate the

cross-sections for absorption from the weight average of the elemental absorption coefficients, μ , i.e.

$$\sigma = m_p \sum (\mu/\rho)_i w_i$$

where m_p is the mass of the plasmid, and $(\mu/\rho)_i w_i$ is the mass attenuation coefficient of the i th element times its fractional weight. The plasmid pBR322 sample was assumed to have the following elemental composition (fractional weights are given in brackets): ^1H (3.4%), ^{12}C (35%), ^{14}N (16%), ^{16}O (29%), ^{31}P (6.9%) and ^{32}S (9.4%). This assumes the prepared DNA sample contains 10% salt and five bound water molecules per basepair (it is not known how well this corresponds to the hydration state of the sample). The same values were assumed for pMSG-CAT DNA. Figure 5 shows the derived photo-absorption cross-section for pBR322 DNA from 4.2 eV to 180 eV using the data of Inagaki *et al.* (1974) and Henke *et al.* (1993). Where the two curves overlap, it is evident that the derivation of cross-section using the Inagaki *et al.* (1974) data is greater by about 25%. This discrepancy may be due to the different underlying assumptions and methods used, i.e. the calculated figures are based on hydrated DNA (plus 10% salt), whereas the measured data are obtained using dry bovine plasma albumin. Also, large uncertainties exist for the photo-ionization cross-sections in solids at these energies.

Using the derived value of σ , the number of absorbed photons per plasmid, I , is:

$$I = I_0 \sigma$$

where I_0 is the total number of incident photons per unit area.

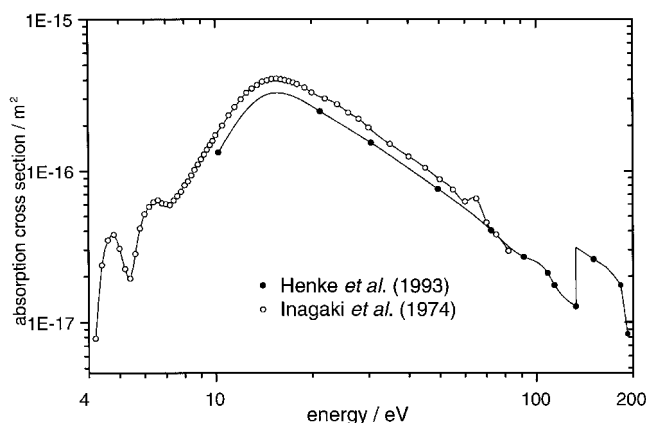

Figure 5. The photon absorption cross-section of pBR322 plasmids as a function of energy, calculated using the data of Inagaki *et al.* (1974) and Henke *et al.* (1993).

3. Results and discussion

The typical measured photon flux in vacuum at the sample position for all relevant combinations and settings of the monochromators, gratings and filters is shown in figure 6. Arrows indicate the energies and filter/grating combinations selected for sample irradiations. The fluxes are those obtained for a synchrotron ring current of 200 mA. Note that the synchrotron, which normally operates continually, is filled twice (or, more recently, once) per day, and drops from about 300 mA to below 100 mA between fills. The measured output is the product of the spectral characteristics of the synchrotron beamline, the transmission characteristics of the monochromator and the optical properties of the filter. For most experiments, the available fluxes were sufficient to deliver the maximum exposures in a few tens of seconds. At higher energies, the maximum exposure (i.e. to induce damage in about 90% of the plasmids) was in the region 10^{14} to 10^{15} photons cm^{-2} . Long exposure times were required at the lowest energies (i.e. 7 eV and 8 eV) due partly to the lower output of the Seya monochromator, but also to a rapidly falling quantum efficiency for DNA damage induction as the energy is reduced below 11 eV. At 7 eV, exposure times ranged from 30 min to 8 h. The calibration factor for the grid was checked at the beginning and the end of each set of exposures and doses to the samples were assumed to be the average of the two readings. Typically, variations up to 5% between the two calibration factors were observed.

It is necessary that the photons reaching the sample are monoenergetic, and that there is no contaminating higher-order radiation. This is important because an increase in sensitivity with increasing energy might be expected, in which case any second-order radi-

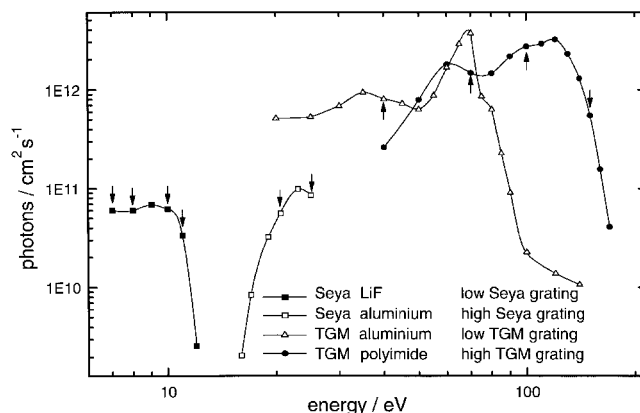

Figure 6. The measured exposure at the sample position (in vacuum) for all combinations of monochromator, VUV window and grating used in this study. The arrows indicate energies used to irradiate DNA samples.

ation (which occurs at twice the energy of the primary radiation) will have a disproportionate effect. Experiments using the Seya monochromator were carried out at 7, 8, 10, 11, 20 and 25 eV. Between 7 eV and 11 eV, the optical properties of the lithium fluoride filter effectively blocks higher-order radiations (lithium fluoride efficiently absorbs photons with energies above 11.5 eV). At 20 eV and 25 eV only the aluminium filter is suitable. Although this will transmit second-order radiation, the output of the grating is almost all first-order at these energies.

Experiments using the TGM were carried out at 40, 70, 100 and 150 eV. The three highest energies were selected using the 'high' grating and the polyimide window. The output of the grating at these energies is virtually all first-order. The 40 eV irradiations were carried out using the 'low' grating and the aluminium filter. This value was chosen to exploit the falling transmission characteristics of the aluminium filter beyond 70 eV, so that contribution of second-order photons at 80 eV is minimized. About 10% of the unfiltered output is second-order at this energy (unpublished data). This is reduced to about 1% by the aluminium filter. It would have been desirable to perform an experiment at 25 eV using the TGM, so that at least one energy could be matched with experiments carried out with the Seya. Unfortunately, only 75% of the output is in first-order at this energy, and the higher orders could not

be blocked by available filtration. For experiments where the DNA is hydrated, only the lithium fluoride and polyimide window can be used, therefore energies that require the aluminium filter (i.e. 25 eV and 40 eV) could not be studied. Another problem is that lithium fluoride is hygroscopic and therefore the transmission of this material degrades when exposed to water vapour. In practice, the window is replaced after 1 week's use (the transmission is reduced by about 30% over this period).

The sample/detector scanning arrangement has been used to map the dose-variation produced by the various monochromator and grating combinations used. A typical example is shown in figure 7. In practice, the beam position and the dose distribution would be slightly different after each refill of the synchrotron ring, and could even vary during the day. For this reason, regular checks of the beam position and distribution were made. However, it was too time-consuming to make a detailed dose-distribution map regularly and therefore the fluorescent quartz window and image-intensified telescope were used instead to make a visual judgement regarding the optimum position of the DNA sample. Typically, the dose-variation over the sample region was about 30%, but was reduced to some extent using the various sample-scanning arrangements available. Although the position of the region could move slightly between synchrotron refills (usually once, or twice per day), the dose distribution did not change.

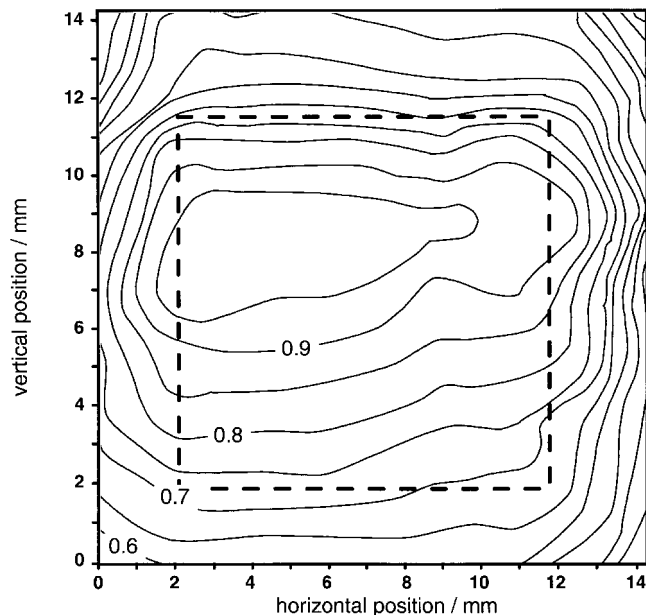

Figure 7. Contour plot showing the typical measured dose distribution (normalized to the peak reading) at the sample position. In this example 11 eV photons were used. The dashed square indicates the nominal position of the sample.

4. Conclusions

Experimental methods have been developed for exposing dry or hydrated plasmid DNA to VUV photons from the 2 GeV electron synchrotron at the CLRC Daresbury Laboratory. By appropriate selection of monochromator, grating and filter, it has been possible to obtain monochromatic photons at a number of selected energies between 7 eV and 150 eV. This facility has been successfully used to measure the action spectrum for DNA damage induction in the dry and hydrated state over this energy range, and is discussed in detail in a subsequent publication.

Acknowledgements

The authors acknowledge the financial support of the Cancer Research Campaign, and financial awards from the Biotechnology and Biological Sciences Research Council and the CCLRC for access and use of the Daresbury synchrotron. The authors also acknowledge the important contribution

made by the Daresbury station managers (Dr Mike MacDonald, Dr Andrew Hopkirk and Dr Ciarán Mythen).

References

- BOTHE, E., GÖRNER, H., OPITZ, J., SCHULTE-FROHLINDE, D., SIDDIQI, A. and WALA, M., 1990, Single- and double-strand break formation in double-stranded DNA upon nanosecond laser-induced photoionization. *Photochemistry and Photobiology*, **52**, 949–959.
- FOLKARD, M., PRISE, K. M., VOJNOVIC, B., DAVIES, S., ROPER, M. J. and MICHAEL, B. D., 1993, Measurement of DNA damage by electrons with energies between 25 and 400 eV. *International Journal of Radiation Biology*, **64**, 651–658.
- FRIEDLAND, W., JACOB, P., PARETZKE, H. G. and STORK, T., 1998, Monte Carlo simulation of the production of short DNA fragments by low-linear energy transfer radiation using higher-order DNA models. *Radiation Research*, **150**, 170–182.
- GOODHEAD, D. T., 1994, Initial events in the cellular effects of ionizing radiations: clustered damage in DNA. *International Journal of Radiation Biology*, **65**, 7–17.
- GURZADYAN, G. G. and GÖRNER, H., 1993, Photolesions in DNA upon 193 nm excitation. *Photochemistry and Photobiology*, **58**, 71–80.
- HENKE, B. L., GULLIKSON, E. M. and DAVIS, J. C., 1993, X-ray interactions: photoabsorption, scattering, transmission, and reflection at $E = 50\text{--}30\,000$ eV, $Z = 1\text{--}92$. *Atomic Data and Nuclear Data tables*, **54**, 181–342.
- HIEDA, K., 1994, DNA damage induced by vacuum and soft X-ray photons from synchrotron radiation. *International Journal of Radiation Biology*, **66**, 561–567.
- INAGAKI, T., HAMM, R. N., ARAKAWA, E. T. and PAINTER, L. R., 1974, Optical and dielectric properties of DNA in the extreme ultraviolet. *Journal of Chemical Physics*, **61**, 4246–4250.
- ITO, T., 1992, The effects of vacuum-UV radiation (50–190 nm) on microorganisms and DNA. *Advances in Space Research*, **12**, 249–253.
- ITO, T., KADA, T., OKADA, S., HIEDA, K., KOBAYASHI, K., MAEZAWA, H. and ITO, A., 1984, Synchrotron system for monochromatic UV irradiation (> 140 nm) of biological material. *Radiation Research*, **98**, 65–73.
- JOHNSON, C. D. and RYMER, T. B., 1967, Existence of collective-excitation energy losses from an electron beam passing through biological materials. *Nature*, **213**, 1045–1047.
- LÜCKE-HUHLE, C. and JUNG, H., 1973a, Energy requirements for damaging DNA molecules I. Energy transfer from metastable states of excited gases. *International Journal of Radiation Biology*, **24**, 221–228.
- LÜCKE-HUHLE, C. and JUNG, H., 1973b, Energy requirements for damaging DNA molecules II. Energy transfer from metastable states of excited gases to double-stranded ϕ X174 RF DNA. *International Journal of Radiation Biology*, **24**, 339–349.
- MICHAEL, B. D., PRISE, K. M., FOLKARD, M., VOJNOVIC, B., BROCKLEHURST, B., MUNRO, I. H. and HOPKIRK, A., 1994, Action spectra for single- and double-strand break induction in plasmid DNA: studies using synchrotron radiation. *International Journal of Radiation Biology*, **66**, 569–572.
- MICHAEL, B. D., PRISE, K. M., FOLKARD, M., VOJNOVIC, B., BROCKLEHURST, B., MUNRO, I. H. and HOPKIRK, A., 1995, Critical energies for *ssb* and *dsb* induction in plasmid DNA: studies using synchrotron radiation. In *Radiation Damage in DNA*, edited by A. F. Fuciarelli and J. D. Zimbrick (Richland, WA: Battelle Press), pp. 251–258.
- NIKJOO, H., GOODHEAD, D. T., CHARLTON, D. E. and PARETZKE, H. G., 1991, Energy deposition in small cylindrical targets by monoenergetic electrons. *International Journal of Radiation Biology*, **60**, 739–756.
- NIKJOO, H., O'NEILL, P., GOODHEAD, D. T. and TERRISSOL, M., 1997, Computational modelling of low-energy electron-induced DNA damage by early physical and chemical events. *International Journal of Radiation Biology*, **71**, 467–483.
- NIKJOO, H., UEHARA, S., WILSON, W. E., HOSHI, M. and GOODHEAD, D. T., 1998, Track structure in radiation biology: theory and applications. *International Journal of Radiation Biology*, **73**, 355–364.
- OTTOLENGHI, A., MONFORTI, F. and MERZAGORA, M., 1997, A Monte Carlo calculation of cell inactivation by light ions. *International Journal of Radiation Biology*, **72**, 505–513.
- PIMBLOTT, S. M. and LAVERNE, J. A., 1995, Energy loss by electrons in DNA. In *Radiation Damage in DNA*, edited by A. F. Fuciarelli and J. D. Zimbrick (Richland, WA: Battelle Press), pp. 3–12.
- RAUTH, A. M. and SIMPSON, J. A., 1964, The energy loss of electrons in solids. *Radiation Research*, **22**, 643–661.
- SONTAG, W. and DERTINGER, H., 1975, Energy requirements for damaging DNA molecules. III. The mechanisms of inactivation of bacteriophage ϕ X174 DNA by vacuum ultraviolet radiation. *International Journal of Radiation Biology*, **27**, 543–552.
- WIRTHS, A. and JUNG, H., 1972, Single-strand breaks induced in DNA by vacuum-ultraviolet radiation. *Photochemistry and Photobiology*, **15**, 325–330.